

PIEDINI



<b>A650</b> sinistro <b>A650SD</b> c/salvadito (31358N)	<b>A652</b> destro <b>A652SD</b> c/salvadito <b>A652B</b> g.basso (12435N)	<b>A651</b> sinistro <b>A651SD</b> c/salvadito (31358W)	<b>A653</b> destro <b>A653SD</b> c/salvadito (12435W)	<b>A654</b> sinistro <b>A654SD</b> c/salvadito <b>A654E</b> economico (31358HN)	<b>A657</b> destro <b>A657SD</b> c/salvadito <b>A657E</b> economico (12435HN)
---	---	---	---	--	--



<b>A655</b> sinistro <b>A655SD</b> c/salvadito <b>A655E</b> economico (31358HW)	<b>A656</b> destro <b>A656SD</b> c/salvadito <b>A656E</b> economico (12435HW)	<b>A655W</b> sinistro extra largo (P36LW)	<b>A656W</b> destro extra largo (P36W)	<b>A658</b> <b>A658SD</b> c/salvadito <b>A658E</b> economico (40322SH)	<b>A659</b> <b>A659SD</b> c/salvadito <b>A659E</b> economico (165010H)
--	--	---	--	---	---



<b>A658R</b> cerniere rigido (40322)	<b>A8000</b> cerniere rigido (165010)	<b>A8001</b> cerniere rigido <b>A8001H</b> snodato (CS40322/40322H)	<b>A658W</b> ciabatta pari <b>A658WSD</b> c/salvadito (121946)	<b>A660</b> ciabatta pari largo <b>A660SD</b> c/salvadito (142058)	<b>A661</b> ciabatta stretta <b>A661SD</b> c/salvadito (142058N) <b>A661E</b> economico
--	---	--	---	---	---

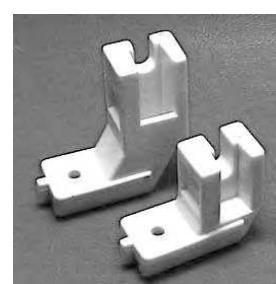
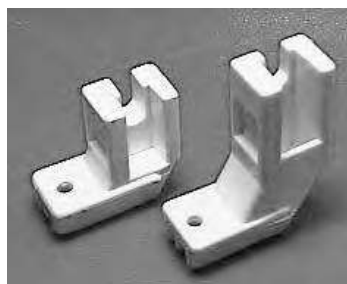

<b>A832</b> (per cerniere invisibili) <b>A832SD</b> c/salvadito <b>A832E</b> economico <b>A832B</b> gambo basso in plastica (S518)	<b>A832A</b> <b>A832ASD</b> c/salvadito <b>A832AE</b> economico (S518N)	<b>A832P</b> gambo alto plastica <b>A832PB</b> gambo basso <b>Per cerniere invisibili in materiale plastico per mc/domestiche</b>	<b>A832AP</b> gambo alto plastica <b>A832APB</b> gambo basso
--	--	---	---

PIEDINI



<b>A662</b> <b>A662SD</b> c/salvadito (19336) <b>A662E</b> economico	<b>A663</b> <b>A663SD</b> c/salvadito 24983 (P35) <b>A663E</b> economico	<b>A664</b> <b>A664SD</b> c/salvadito 52427 (P351) <b>A664E</b> economico	<b>A664K</b> foro stretto (P351K)	<b>A665</b> <b>A665SD</b> c/salvadito 127233 (P127) <b>A665E</b> economico	<b>A715H</b>  (12144H) <b>A715HSD</b> Con salvadito
---	---	--	---	---	---



<b>A664PT</b> Piedino suola fibra Rivestito in Teflon	<b>A715HLD</b> (12144HLD)	<b>A664/P352</b>	<b>113280</b> Brother	<b>150789</b> Brother	<b>147308</b> Singer
---	------------------------------	------------------	--------------------------	--------------------------	-------------------------

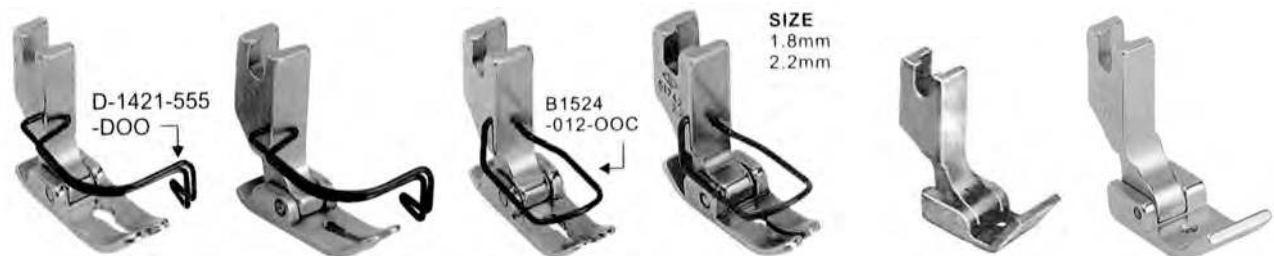

<b>B1511-543-BBA</b> piedino Juki	<b>B1524 -012-BBA</b> piedino Juki	<b>B1524-012-0B0</b> piedino Juki <b>B1524-012-0A0</b> (senza salvadito)	<b>P51742</b> piedino Pfaff	<b>A712</b> 3/8	<b>A703</b> 1/2 <b>A704</b> 3/4 <b>A705</b> 1" piedini per orlatori – varie larghezze (S542)
--------------------------------------	---------------------------------------	---	--------------------------------	--------------------	---



<b>A717</b> (P361)	<b>A718</b> (P360)	<b>A699</b> piccolo (S538)1/4 <b>A700</b> medio (S539)1/2 <b>A701</b> largo (S540) 1" <b>A702</b> extra largo (S541)	<b>A822</b> sinistro 1/32-1/16-3/32-1/8-3/16-1/4 (12463HL)	<b>A821</b> destra 5/16-3/8-1/2 (12463HR)	<b>A690</b> 1/32-1/16-1/8-3/16-1/4  <b>A690M</b> molla ricambio	<b>A821REG</b> destra regolabile
-----------------------	-----------------------	---	---	--	--	-------------------------------------

PIEDINI



**A880** destro  
**A881** sinistro  
 piedini con guida elastica  
 1/32-1/16-1/8-3/16-1/4  
 (SP18) (SP18L)

**A693**  
 piedino trapuntatore  
 (S521)

**A707**  
**A708**  
 mezzi piedini con guida destra  
 (P81) (P801)



**A709**  
 piedino con guida dx  
 (P803)

**A837**  
 (P34)

**A838**  
**A666**  
 piedini sagomati per bordatori  
 (P38) (12142C)

**A667**  
**A668**  
 piedini arricciatori regolabili  
 (S952) (S950)  
**A667E** economico **A668E** economico  
**A667SD** con salvadito **A668SD** con salvadito



**A694** gradino basso  
**A695** gradino medio  
**A696** gradino alto  
 (P50N-P50-P50H)

**A697**  
 arricciatore con inserto tessuto  
 (P5) (P5W)

**A719**  
 piedini con ciabatta grezza per lavorazioni speciali  
 foro sinistro (SP62)

**A720**  
 destro (SP63)

**A721**  
 centrale (SP64)



**A824** sinistro  
 1/8-3/16-1/4  
 (36069HL)

**A825** destro  
 1/8-3/16-1/4  
 (36069HR)

**A691** sinistro  
 1/8-3/16-1/4  
 (36069L)

**A692** destro  
 1/8-3/16-1/4  
 (36069R)

**A836** sinistro  
 1/8-3/16-1/4  
 (31358L)

**A835** destro  
 1/8-3/16-1/4  
 (12435R)

**PIEDINI**



<b>A823</b> 1/8-3/16-1/4 (P69D)	<b>A713</b> pedino con guide (S524)	<b>A713B</b> pedino con guide (35137)	<b>A710</b> per cerniere regolabile gambo alto	<b>A711</b> per cerniere regolabile gambo basso
---------------------------------------	---	---	--	---



<b>A689</b> con tubo centrale misure tubi fornibili : 1/8-3/16-1/4-5/16-3/8-1/2-5/8-3/4-1"	<b>A689S</b> tubo a sinistra (S10C-R-L)	<b>A689D</b> tubo a destra	<b>A669</b> 1/8 <b>A671</b> 1/4 <b>A673</b> 1/2	<b>A670</b> 3/16 <b>A672</b> 3/8	<b>A689R</b> piedini guida fettuccia tubo intercambiabile 1/8-3/16-1/4-3/8-5/16-1/2 <b>A689RT</b> solo tubo varie misure <b>A689V</b> vite
--	---	-------------------------------	---	-------------------------------------	---

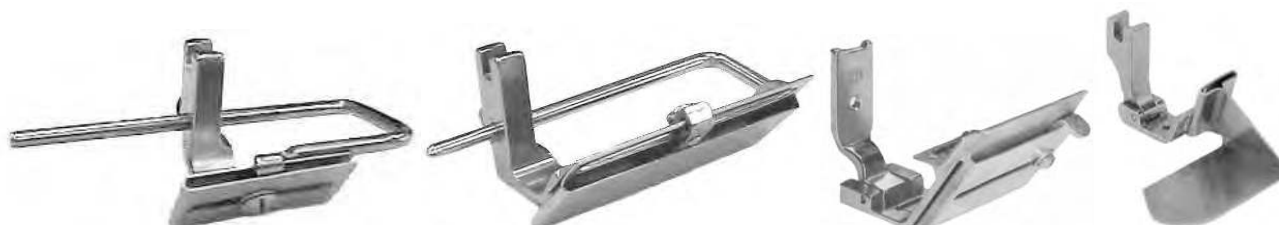

<b>A706BIS</b> pedino con tubo guida nastro regolabile tubi intercambiabili in dotazione	<b>A706</b> pedino guida nastro regolabile tubo grande fisso	<b>S570G</b> guida nastro regolabile per ZZ attacco piatto	<b>A689G</b> guida nastro mm 12,7 con appoggio (S532)
--	--	--	---



<b>A730</b> Normale diritto	<b>A731</b> trasporto ago	<b>A732</b> zig zag	<b>A733</b> trasporto ago DK 212
--------------------------------	------------------------------	------------------------	-------------------------------------

**PIEDINI MULTIGUIDA – GUIDANASTRO – GUIDA DESTRA – GUIDA SINISTRA**

Sono fornibili anche con attacco lungo PFAFF 142/1242/1245 (**A734**) e Necchi 881 (**A735**)

## PIEDINI



<b>A674</b>	Lot 1- 1/16	(snodati)	<b>A674S</b>	(pesante)	<b>A683</b>	Lot 02-1/8	<b>A674R</b>	<b>A674S/ZZ3</b>	mm 3
<b>A675</b>	Lot 11/2- 5/64		<b>A675S</b>		<b>A684</b>	Lot 04-3/16	ribattitore	<b>A674S/ZZ5</b>	mm 5
<b>A676</b>	Lot 2- 3/32		<b>A676S</b>		<b>A685</b>	Lot 06-1/4	1/8-3/16-7/32-1/4		
<b>A677</b>	Lot 21/2-1/8		<b>A677S</b>		<b>A686</b>	Lot 07-5/16		orlatore ZZ snodato	mm 3/5
<b>A678</b>	Lot 3-5/32		<b>A678S</b>		<b>A687</b>	Lot 09-3/8			
<b>A679</b>	Lot 4-3/16		<b>A679S</b>		<b>A688</b>	Lot 095-7/16			
<b>A680</b>	Lot 5-7/32		<b>A680S</b>						
<b>A681</b>	Lot 6-1/4		<b>A681S</b>						
<b>A682</b>	Lot 71/2-5/16		<b>A682S</b>						

< piedini orlatori >



<b>A800</b>	<b>A801</b>	<b>A802</b>	<b>A8002</b>
pieдино rotolatore per foulard	orlatore con molla per giunte	pieдино orlatore fisso	pieдино bordatore
1/32-1/16-1/8-3/16-1/4	1/32-1/16-1/8-3/16-1/4	1/32-1/16-1/8-3/16-1/4	per profili e bordi
(490358)	(490359)	(490360)	mm 3 - 5 - 6,5

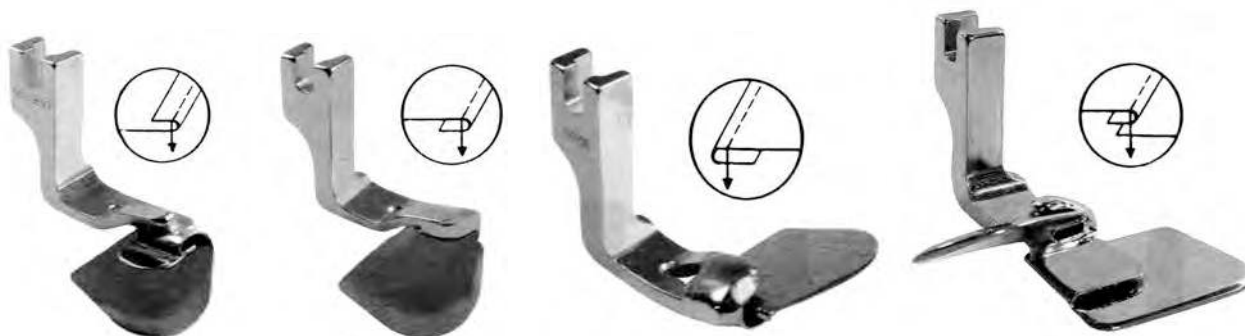

<b>A920</b>	<b>A921</b>	<b>A922</b>	<b>A923</b>
pieдино ribattitore	pieдино ribattitore	pieдино ribattitore	pieдино ribattitore
3/16-1/4	3/16-1/4	3/16-1/4	3/16-1/4
(490357)	(490355)	(490356)	(H5020)

**PIEDINI**



Destro      con salvadito      sinistro      per maglina destro      maglina sinistro      doppio  
**PIEDINI COMPENSATORI INDUSTRIALI produzione YS**

<b>DESTRO:</b>		<b>DESTRO MISURA PIENA</b>		<b>DESTRO PER MAGLINA</b>		<b>MAGLINA (prod. nazionale)</b>	
A750J	21R 1/32 largo	A750J1	mm 1	A795	1/32	A795NAZ	1/32 destro
A751J	210 1/32 stretto	A752J2	mm 2	A795-3/32	3/32	A795SXNAZ	1/32 sinistro
A752J	211 1/16 largo	A753J3	mm 3	A795S	1/32 stretto	A795-3/32NAZ	3/32 destro
A752JS	211N 1/16 stretto	A753J4	mm 4	A796	1/16	A795-3/32SXNAZ	sinistro
A752J3/32	3/32	A754J5	mm 5	A796-5/32	5/32	A796NAZ	1/16 destro
A752J5/32	5/32	A755J6	mm 6	A796S	1/16 stretto	A796SXNAZ	1/16 sinistro
A753J	212 1/8	A755J7	mm 7	A797	1/8	A797NAZ	1/8 destro
A754J	213 3/16	A756J8	mm 8	A798	3/16	A797SXNAZ	1/8 sinistro
A755J	214 1/4	A756J9	mm 9	A799	1/4	A798NAZ	3/16 destro
A756J	215 5/16	A757J10	mm10	A799-1/2	1/2	A798SXNAZ	3/16 sinistro
A757J	216 3/8	<b>SINISTRO MISURA PIENA</b>		A799-3/8	3/8	A799NAZ	1/4 destro
A758J	218 1/2	A760J1	mm 1	<b>SINISTRO PER MAGLINA</b>			
<b>SINISTRO:</b>		A761J2	mm 2	A795SX	1/32		
A759J	22L 1/32 largo	A762J3	mm 3	A795SSX	1/32 stretto		
A760J	220 1/32 stretto	<b>DOPIO COMPENSATORE</b>		A796SX	1/16		
A761J	221 1/16 largo	A765J	230 1/32	A796SSX	1/16 stretto		
A761JS	221N 1/16 stretto	A766J	231 1/16	A797SX	1/8		
A761J3/32	3/32	A766J/232	1/8	A798SX	3/16		
A762J	222 1/8	A766J/233	3/16	A799SX	1/4		
A763J	223 3/16	A766J/234	1/4				
A764J	224 1/4						
A764J/225	5/16						
A764J/226	3/8						
A764J/228	1/2						

**TUTTI I COMPENSATORI SONO FORNIBILI CON SALVADITO. Nell'ordine aggiungere "SD" al codice articolo. Esempio: A751J diventa A751JSD**

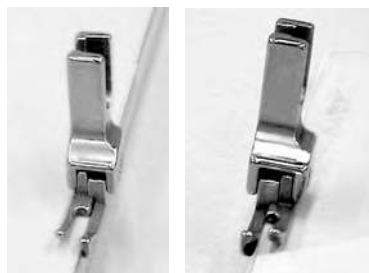

Alto spessore - economici FIT - economici import - prod. nazionale - extra stretti per lavorazioni speciali

<b>Compensatori destri per alti spessori, Nazionali</b>		<b>Compensatori economici di importazione:</b>		<b>Compensatori prod. Nazionale</b>			
A750A1	mm 1	A750E	1/32 destro	<b>Destri</b>		<b>Sinistri</b>	
A752A1,5	mm 1,5	A751E	1/32 destro stretto	A750NAZ	1/32	A759NAZ	1/32
A752A2,4	mm 2,4	A752E	1/16 destro	A751NAZ	1/32 stretto	A760NAZ	1/32 stretto
A753A3	mm 3	A752SE	1/16 destro stetto	A752NAZ	1/16	A761NAZ	1/16
A753A4	mm 4	A753E	1/8 destro	A753NAZ	1/8	A762NAZ	1/8
A754A5	mm 5	A754E	3/16 destro	A754NAZ	3/16	A763NAZ	3/16
A755A6	mm 6	A755E	1/4 destro	A755NAZ	1/4	A764NAZ	1/4
<b>Compensatori economici "FIT" (acciaio scuro simil YS)</b>		A756E	5/16 destro	A756NAZ	5/16		
A751F	1/32 destro	A757E	3/8 destro	A757NAZ	3/8		
A752F	1/16 destro	A758E	1/2 destro	A758NAZ	1/2		
A760F	1/32 sinistro	A759E	1/32 sinistro	<b>Compensatori extra stretti per lavorazioni speciali</b>			
A761F	1/16 sinistro	A760E	1/32 sinistro stretto	A751JSS	1/32 destro		
		A761E	1/16 sinistro	A752JSS	1/16 destro		
		A761SE	1/16 sinistro stretto	A760JSS	1/32 sinistro		
		A762E	1/8 sinistro	A761JSS	1/16 sinistro		
		A763E	3/16 sinistro				
		A764E	1/4 sinistro				

## PIEDINI



compensatori gambo basso <b>A751B 1/32</b> <b>A752B 1/16</b> <b>A752B 2,4-3-4-5-6mm</b>	<b>A833B</b> zig zag g.basso comp.doppio mm 3 - 5 - 6 =B3 - B5 - B6	doppio-zig zag g.alto <b>A833/5</b> mm.5 <b>A833/3</b> mm.3	<b>A834</b> comp.zig zag destra	<b>A834SX</b> comp.zig zag sinistro	<b>A834SXST</b> comp. zig zag sinistro stretto <b>A834ST</b> destra stretto
--	---	---	---------------------------------------	---	---



<b>A816 (601)</b> <b>A817 (602)</b> <b>A817 (603)</b> <b>A817 (604)</b> nazionali: <b>A817/601N</b> <b>A817/602-3-4-5-6N</b>	compensatori per bordatori e orlatori <b>A817ZZ</b> mm 3 e mm 5	<b>A748</b>	<b>A749</b>	<b>A790</b> (21-14) 1/32-1/4 <b>A791</b> (211-14) 1/16-1/4 <b>A792</b> (21-15) 1/32-5/16 <b>A793</b> (211-15) 1/16-5/16 <b>A794</b> (211-16) 1/16-3/8 <b>A790/13</b> (21-13) 1/32-3/16 <b>A791/13</b> (211-13) 1/16-3/16 <b>A792/18</b> (21-18) 1/32-1/2	doppia compensazione semplici e doppi <b>A790DO</b> <b>A791DO</b> <b>A792DO</b> <b>A793DO</b> <b>A792/16</b> (21-16) 1/32-3/8 <b>A794/18</b> (211-18) 1/16-1/2
--	---	-------------	-------------	---	--

( I piedini a doppia compensazione sono fornibili a richiesta anche per trasporto punta ago, ma solo di produzione nazionale )



<b>A752JG</b> compensatori con guida fissa destra e sinistra	<b>A761JG</b>	<b>P55030</b> Pfaff 438 mm 3,5	<b>P55112</b> Pfaff 438 mm.4,5	<b>P054501NO</b> Pfaff 438 mm.6	<b>P55106</b> Pfaff 438 mm 10	<b>N110409</b> Necchi 720 e varie
--	---------------	-----------------------------------	-----------------------------------	------------------------------------	----------------------------------	--------------------------------------



<b>N956099</b> Necchi 720	<b>112800</b> Brother	<b>541566</b> Singer	<b>541781</b> ZZ 10 mm per nervature (piedini ZZ larghi per Threestitch Singer/Brother)	<b>543939</b> Singer	<b>111994</b> Brother
------------------------------	--------------------------	-------------------------	---	-------------------------	--------------------------

PIEDINI



R-1  
R-1 (HM1-1) LIGHT  
R-2 (HM1-2) MEDIUM  
R-3 (HM1-3) HEAVY



SPK-3



**A714** a rulli cuc.diritta      **A660RO** a rulli cuc.diritta      **A714SPK3** a rulli cuc.diritta      **A714ZZ** a rulli zig zag



R-36N

R-36N (HM2-3)  
R-36 (HM2-1)  
R-36W  
R-36I (HM1-4)



R-36LN

R-36LN (HM2-4)  
R-36L (HM-2-2)  
R-36LW  
R-36O



**A657RO** mezzo piedino a rulli destro      **A654RO** mezzo piedino a rulli sinistro      **Y2107084RO** piedino per tegliacuci 2 aghi Yamato/Pegasus/Juki ecc.

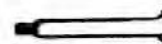

**AV334**  
viti per compensatori



**AV335**  
molle per compensatori

Piedini compensatori con rulli – destri e sinistri			
<b>A750RO</b>	1/32 destro	<b>A753RO5/32</b>	5/32 destro
<b>A751RO</b>	1/32 destro stretto	<b>A754RO</b>	3/16 destro
<b>A752RO</b>	1/16 destro	<b>A755RO</b>	1/4 destro
<b>A752SRO</b>	1/16 destro stretto	<b>A759RO</b>	1/32 sinistro
<b>A752RO5/64</b>	5/64 destro	<b>A760RO</b>	1/32 sinistro stretto
<b>A752RO3/32</b>	3/32 destro	<b>A761RO</b>	1/16 sinistro
<b>A753RO</b>	1/8 destro	<b>A761SRO</b>	1/16 sinistro stretto
		<b>A761RO5/64</b>	5/64 sinistro
		<b>A761RO3/32</b>	3/32 sinistro
		<b>A762RO</b>	1/8 sinistro
		<b>A763RO</b>	3/16 sinistro
		<b>A764RO</b>	1/4 sinistro



**A804LP** piedino con anelli nailon      **A815LP** mezzi piedini con anelli in nailon  
**A804LPA** anelli in nailon ricambio      **A814LP**      **A821R** ad anelli nailon con guida battuta dx  
battuta: 1/32 – 1/16 – 1/8 – 3/16



## PIEDINI



<b>A804</b> piedino teflon (T35) <b>A810</b> suoletta ricambio <b>A804SD</b> con salvadito <b>A805 gambo basso</b> famiglia	<b>A804W</b> largo <b>A804WSD</b> con salvadito <b>A810W</b> suoletta ricambio (T35W)	<b>A811</b> <b>A811SD</b> con salvadito <b>A811B</b> suoletta ricambio (T350)	<b>A804BIS</b> <b>A804BISB</b> suoletta ricambio (T35C)	<b>A808BIS</b> rivestito teflon (24983)
--	---	---	--	---



<b>A814</b> (T36LN) <b>A814SD</b> con salvadito <b>A814B</b> suoletta ricambio	<b>A814W</b> <b>A814WSD</b> c/salvadito <b>A814WB</b> suoletta	<b>A815</b> (T36N) <b>A815SD</b> c/salvadito <b>A815B</b> suoletta	<b>A815W</b> <b>A815WSD</b> c/salvadito <b>A815WB</b> suoletta	<b>A820</b> (T363) <b>A820SD</b> c/salvadito <b>A820B</b> suoletta
--	--	--	--	--



Destri	c/salvadito	Suolette	Sinistri	c/salvadito	suolette
<b>A780</b> 1/32	<b>A780SD</b>	<b>A780B</b>	<b>A780S</b> 1/32	<b>A780SSD</b>	<b>A780SB</b>
<b>A780/210</b> 1/32 stretto	<b>A780/210SD</b>	<b>A780B/210</b>	<b>A780S/220</b> 1/32 stretto	<b>A780SSD/220</b>	<b>A780SB/220</b>
<b>A781</b> 1/16 largo	<b>A781SD</b>	<b>A781B</b>	<b>A781S</b> 1/16	<b>A781SSD</b>	<b>A781SB</b>
<b>A781/211N</b> 1/16 stretto	<b>A781/211NSD</b>	<b>A781B/211N</b>	<b>A781S/221</b> 1/16 stretto	<b>A781SSD/221</b>	<b>A781SB/221</b>
<b>A781</b> 3/32	<b>A7813/32SD</b>	<b>A781B3/32</b>	<b>A782S</b> 1/8	<b>A782SSD</b>	<b>A782SB</b>
<b>A782</b> 1/8	<b>A782SD</b>	<b>A782B</b>	<b>A783S</b> 3/16	<b>A783SSD</b>	<b>A783SB</b>
<b>A783</b> 3/16	<b>A783SD</b>	<b>A783B</b>	<b>A784S</b> 1/4	<b>A784SSD</b>	<b>A784SB</b>
<b>A784</b> 1/4	<b>A784SD</b>	<b>A784B</b>			
<b>A785</b> 5/16	<b>A785SD</b>	<b>A785B</b>			
<b>A786</b> 3/8	<b>A786SD</b>	<b>A786B</b>			



<b>A812</b> zz mm5 <b>A812/12</b> mm 12 <b>A812B</b> suoletta <b>A812B12</b> suoletta	<b>A832AT</b> tutto teflon per cerniere invisibili <b>A832AT S</b> suoletta	<b>A804TPA</b> trasporto punta d'ago	<b>A813</b> zz gambo basso suola teflon	<b>A807</b> zz gambo basso rivestito in teflon	<b>A664PT</b> suoletta in fibra rivestito in teflon
--	--	--------------------------------------	---	--	---



Non essendo più fornibili molti piedini con suoletta rivestita in teflon, vi ricordiamo che sono disponibili vari tipi di teflon adesivo e non.. che può essere sagomato ed applicato su ogni superficie. (vedi pag.77)

**PIEDINI ATTACCO PIATTO PER SINGER, JUKI, BROTHER, DURKOPP**



**MS112** 3/16-1/4    **S570REG** 3/16 1/4    **S570C** con guida compensata 2 aghi 1/8 - 3/16 - 1/4 - 3/8    vari zig zag Singer 107/457  
chiedere x mis.nastro



compensatori zz bilanciati destro    sinistro    comp.zz stretti destro    sinistro    zz.con guida elastica regolabile zz.    orlatore    guidanastro



Zig zag con guida mobile    zig zag diversi per Singer 107/457 e similari



DUE AGHI COMPENSATI PER : SINGER-JUKI-DURKOPP-BROTHER

**GUIDANASTRO** regolabile    **S570** 1/8-3/16-1/4-3/8-1/2 distanza aghi battuta a 1/32 o 1/16    **S570L** sinistro    **S570DG** doppio



**A736** guida multipla 3/16-1/4    **A737** guida multipla zig zag    **S570G** guida nastro regolabile    **MT107** teflon zz kl 107-457    **MT112** teflon 2 aghi da 1/8 a 1/2 kl 112-212    **259635** 2 aghi stretto 1/8-3/16-1/4 kl 112-212

**PIEDINI A ROTELLA - PIEDINI ADLER**

**PIEDINI A ROTELLA**



ALFA 2-82297 mm.22  
2-82344 mm.32



Pfaff 119681



Pfaff 119787



Pfaff 51155



Pfaff 51157



Pfaff 51159



ALFA 2-80249  
attacco basso



ALFA 2-82311 mm. 22  
2-82314 mm. 32



ALFA 2-82315



ALFA 3-81299 mm.22  
3-81300 mm.32

Singer 12264 mm. 22  
12265 mm. 25  
12267 mm. 30

**PIEDINI ADLER**

KI.67-68-69-167



067-22-072-3

067-22-063-3



167-22-019-3

167-22-018-3 (mm.8)



069-00-394-3

069-22-121-3 (mm.6)



069-00-391-0

069-22-117-3

069-22-1003  
per bordare



067-22-078-0

067-22-070-6



067-22-079-0

067-22-070-0

## PIEDINI ADLER



S67 3/16 set completo import  
S67 1/4 set completo import

067-22-076-0 3/16  
067-22-077-0 1/4

067-22-068-3 3/16  
067-22-069-3 1/4



A8009

A8010

con scanalatura da 2 a 12 mm

A8011

A8012



A8013

da 2 a 12 mm.

A8014

A8015

da 2 a 8 mm.

A8016



A8017

A8018

da 2 a 12 mm.

A8019

A8020

### PIEDINI PER ADLER 69-169-269

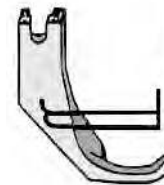
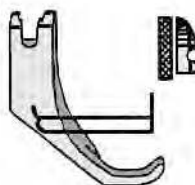
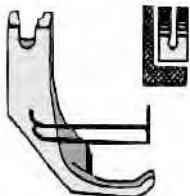

069-003943

069-221113

069-221163

069-221143

069-221123

069-221143

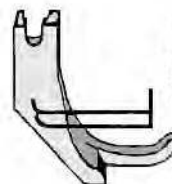
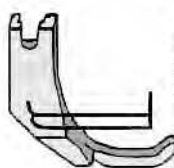

069-221153

069-221133

069-221113

069-221133

**PIEDINI ADLER**



<b>A8005</b>	<b>A8006</b>	<b>A8007</b> da 3 a 7 mm.	<b>A8008</b>	<b>367-22-099-3</b>	<b>467-22-001-3</b>
--------------	--------------	---------------------------	--------------	---------------------	---------------------

**PIEDINI ADLER PER FIBBIE**

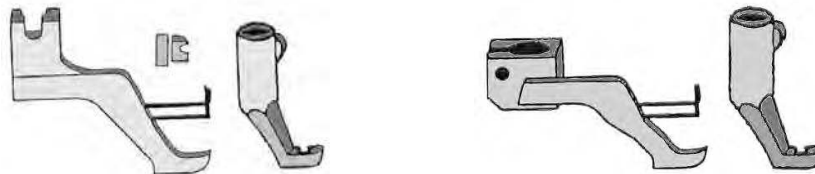

forniti in coppia	ADLER 67/69/167/267/269 <b>A69-2211</b>	forniti in coppia	ADLER 467/767 <b>A467-2211</b>
-------------------	--	-------------------	-----------------------------------

**PIEDINI 2 AGHI ADLER 467.767.768**

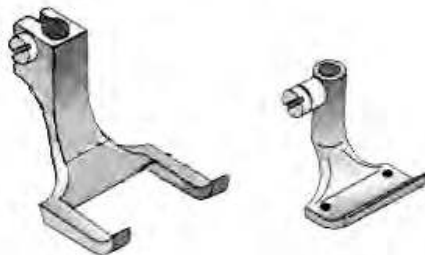

misura/mm.	esterno	interno
3	367222463	067222313
4	367222473	067222323
5	367222483	067222333
6	367222093	067222343
8	367222103	067222353
10	367222013	067222383
12	367222313	067222393
14	367222323	067222413
16	367222333	067222423
18	367222533	067222433
20	367222543	067222443
22	367222413	067222773
24	367223163	067222453

**PIEDINI PER 2 AGHI ADLER 67.167.267**



4,0 mm	<b>067 22250 3</b>	<b>067 22232 3</b>	<b>067 20397 0</b>	<b>067 21340 0</b>	<b>068 23207 4</b>
5,0 mm	<b>067 22251 3</b>	<b>067 22233 3</b>	<b>067 20366 0</b>	<b>067 21343 0</b>	<b>068 23208 4</b>
6,0 mm	<b>067 22252 3</b>	<b>067 22234 3</b>	<b>067 20389 0</b>	<b>067 21346 0</b>	<b>068 23209 4</b>
8,0 mm	<b>067 22254 3</b>	<b>067 22235 3</b>	<b>067 20363 0</b>	<b>067 21349 0</b>	<b>068 23211 4</b>
10,0 mm	<b>067 22256 3</b>	<b>067 22238 3</b>	<b>067 20364 0</b>	<b>067 21352 0</b>	<b>068 23212 4</b>
12,0 mm	<b>067 22257 3</b>	<b>067 22239 3</b>	<b>067 20365 0</b>	<b>067 21355 0</b>	<b>068 23215 4</b>
14,0 mm	<b>067 22259 3</b>	<b>067 22241 3</b>	<b>067 20375 0</b>	<b>067 21359 0</b>	<b>068 23218 4</b>
16,0 mm	<b>067 22260 3</b>	<b>067 22242 3</b>	<b>067 20376 0</b>	<b>067 21362 0</b>	<b>068 23221 4</b>
18,0 mm	<b>067 22261 3</b>	<b>067 22243 3</b>	<b>067 20399 0</b>	<b>067 21365 0</b>	<b>068 23222 4</b>
20,0 mm	<b>067 22262 3</b>	<b>067 22244 3</b>	<b>067 20367 0</b>	<b>067 21367 0</b>	<b>068 23223 4</b>
22,0 mm	<b>067 22278 3</b>	<b>067 22277 3</b>	<b>067 20320 0</b>	<b>067 21369 0</b>	<b>068 23224 4</b>
24,0 mm	<b>067 22263 3</b>	<b>067 22245 3</b>	<b>067 20322 0</b>	<b>067 21374 0</b>	<b>068 23241 4</b>

**PIEDINI ADLER**

**Dettaglio piedini normali per griffa da 6 mm**

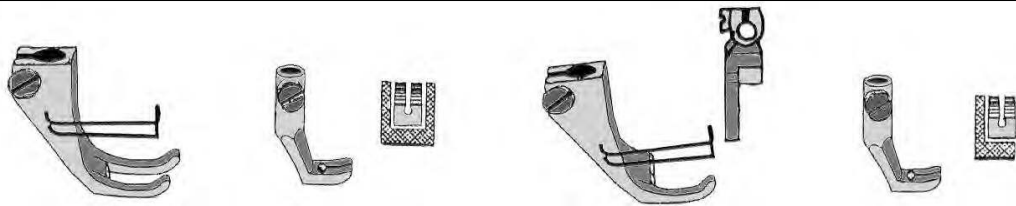

A6-367220983

067220633

C6

067220633

**Dettaglio mezzi piedini DX e SX per griffa da 6 mm**

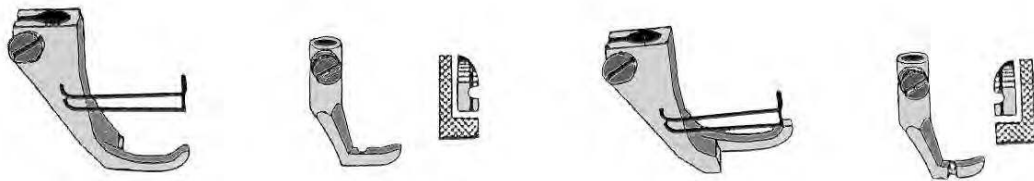

D6

067220713

E6

067220703

**Dettaglio piedini normali per griffa da 8 mm**

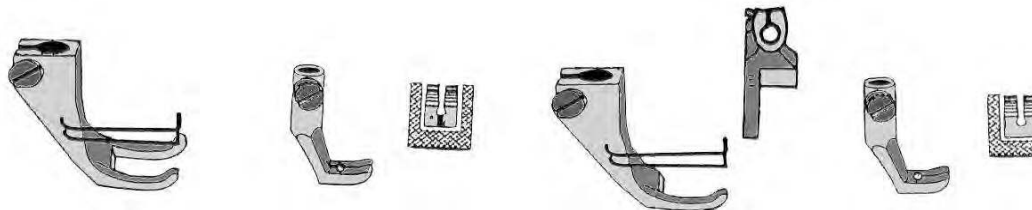

A8-367220993

467220013  
367221443 foro chiuso

C8

467220013

**Dettaglio mezzi piedini DX e SX per griffa da 8 mm**

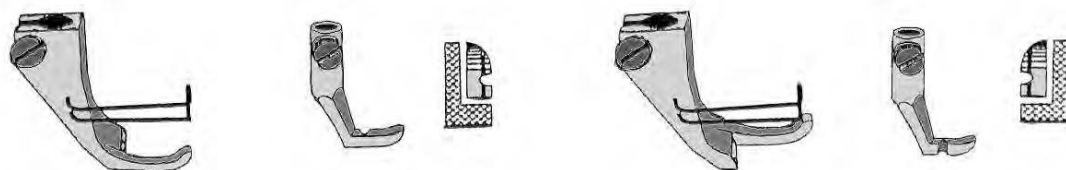

D8-367220283

167220323

E8-367220343

167220303



**Piedini con scanellatura per Adler 467**

**AD467DE**      **AD467DI**  
da mm.3 a mm.12

**AD467MDE**    **AD467MDI**  
da mm.3,5 a mm.8

**AD467SE**      **AD467SI**  
da mm.4 a mm.7

**PIEDINI ADLER 267-268 2 AGHI BILANCINO**

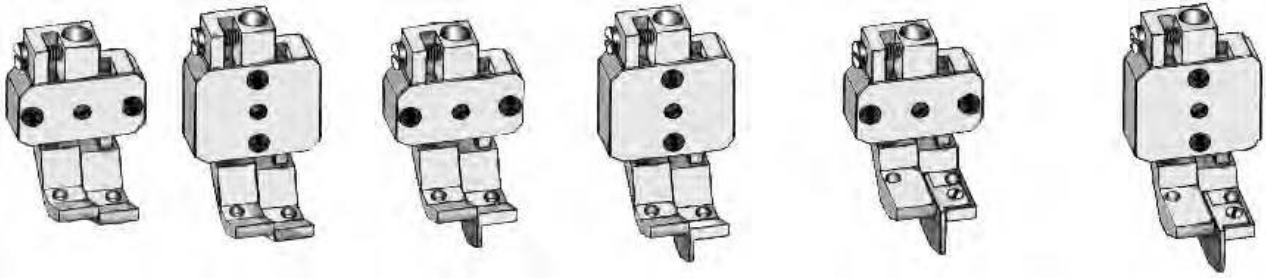

**A8045B**  
Basso  
Aghi fissi

**A8045**  
alto  
disinnestabili

**A8045GB**  
basso con guida fissa  
aghi fissi

**A8045G**  
alto con guida fissa  
disinnestabili

**A8045GBR**  
basso con guida remov.  
aghi fissi

**A8045GR**  
alto con guida remov.  
disinnestabili

Misure fornibili : 4,8 – 6 – 6,4 – 8 – 10 – 12 – 14 mm

**PIEDINI DURKOPP**

KI.212 trasporto ago + KI 244 a 2 aghi



**212-1193**

**A2403**  
(212-903)

**212-1643**

**212-887**

**A832ATA212**  
cerniere invisibili con prua e senza prua

**A832TA212**

**A2411**  
suola mm 5,4

**A2413**  
mm 7



**A2410**  
suola mm.5,4

**A2412**  
suola mm.7

**A2402**  
suola mm.5,4

**A2402L**  
suola mm.7

**A2403T**  
tutto teflon  
**A2403TB**  
Suola ricambio

**A2402SXXD**  
mezzo per cerniere  
regolabile dx sx

6D

**PIEDINI DURKOPP**



**A827** 1/32 destro  
**A828** 1/16  
**A829** 1/8  
**A830** 3/16  
**A831** 1/4

**A2404** 1/32 sinistro  
**A2405** 1/16  
**A2406** 1/8  
**A2407** 3/16  
**A2408** 1/4

**A733**  
 piedino doppia battuta  
 e guidanastro regolabile

**A2420** mm 4,8  
**A2421** mm 6,4  
 2 aghi x DK244

**A2422** mm 4,8  
**A2423** mm 6,4  
 x DK 244 suola stretta

compensatori per DK244 vedi pag. 137: A890B - A891B

**PIEDINI PER TRASPORTO AGO DURKOPP 272 = PFAFF 461- 481**



**A664TPA**

**A665TPA**

**A662TPA**

**A2400**

**A2401**

**272-6801**

**A717TPA**



**A718TPA**

**A897**  
 suola mm.5,4

**A897L**  
 suola mm.7

**A898**  
 suola mm.5,4

**A898L**  
 suola mm.7

**A896**  
**A896L** suola mm.7

**A659TPA**



**A894** destro  
 compensatori trasporto ago  
 1/32 - 1/16 - 1/8 - 3/16 - 1/4 - 3/8 - 1/2  
**A899** compensatore doppio 1/16

**A895** sinistro

**A832ATA**  
 cerniere invisibili con prua e senza prua

**A832TA**

**A896SXD**  
 mezzo piedino  
 regolabile dx sx

**A731**  
 piedino doppia battuta  
 guida nastro regolabile

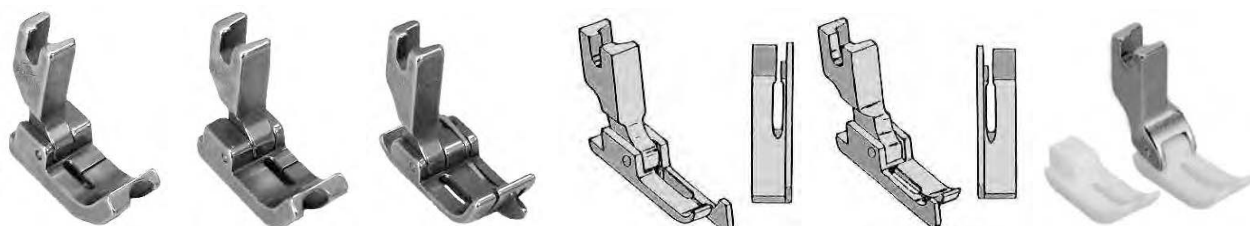

**A825TPA**  
 1/8-3/16-1/4-5/16

**A824TPA**

**A880TPA**  
 1/32-1/16-1/8-3/16-1/4  
**A881TPA** guida a sinistra

**A821TPA**  
 1/32-1/16-1/8-3/16-1/4  
 a richiesta per DK212 = **A821DKTPA** - **A822DKTPA**

**A822TPA**

**A804TPA**  
 suola teflon



## PIEDINI NECCHI



<b>A665</b> kl.830-885	<b>A664</b> kl.830-885	<b>956378</b> kl.830-885	<b>956517</b> kl.885	<b>956653</b> kl.885	<b>110409</b> kl.720-750	<b>956099</b> kl.720-750
---------------------------	---------------------------	-----------------------------	-------------------------	-------------------------	-----------------------------	-----------------------------



<b>A833/3</b> mm.3 <b>A833/5</b> mm.5 comp.doppio zz.	<b>146409</b> kl.831	<b>956332</b> kl.831	<b>A906</b> kl.831 ciabatta mm 5,4 <b>A906L</b> mm 7	<b>A907</b> kl.831 ciabatta mm 5,4 <b>A907L</b> mm 7	<b>A905</b> cerniere kl. 831
---	-------------------------	-------------------------	--	--	---------------------------------



<b>A900</b> destro 1/32-1/16-1/8-3/16-1/4 compensatori kl.831	<b>A900S</b> sinistro 1/32-1/16-1/8-3/16-1/4 compensatori kl.831	<b>A902</b> kl.881	<b>A903</b> kl.881	<b>A904</b> kl.881	<b>961761</b> kl.881	<b>961789</b> kl.881
---	--	-----------------------	-----------------------	-----------------------	-------------------------	-------------------------



<b>A901</b> destro 1/32-1/16-1/8-3/16-1/4 5/16-3/8 compensatori kl.881	<b>A901S</b> sinistro 1/32-1/16-1/8-3/16-1/4 5/16-3/8 compensatori kl.881	<b>30715</b> mm.4,8 <b>961044-300</b> mm.6 <b>961044-310</b> mm.6,4 kl.921-925 stretto:vedi Pfaff 40811ST	destri <b>A890</b> 4,8-1 <b>A890</b> 4,8-2 <b>A891</b> 6,4-1 <b>A891</b> 6,4-2	sinistri <b>A892</b> 4,8-1 <b>A892</b> 4,8-2 <b>A893</b> 6,4-1 <b>A893</b> 6,4-2 kl.921-925	destro <b>A818</b> 4,8-1 <b>A818</b> 4,8-2 <b>A819</b> 6,4-1 <b>A819</b> 6,4-2 kl.921 tipo vecchio	doppio <b>A818D</b> 4,8-2 <b>A819D</b> 6,4-2 kl.921 tipo vecchio
---	--	---	--	--	---	---

## PIEDINI NECCHI



**961799-300** mm.4,8  
**961773-300** mm.6  
**961773-310** mm.6,4  
 kl.971

**A890B** 4,8-1 destro  
**A890B** 4,8-2  
**A891B** 6,4-1  
**A891B** 6,4-2  
 kl.971 = DK244

**A818B** 4,8-1 destro  
**A818B** 4,8-2  
**A819B** 6,4-1  
**A819B** 6,4-2  
 kl.971

**A818BD** 4,8-2  
**A819BD** 6,4-2  
 kl.971

**961799S**  
 4,8 – 6,4 stretto  
 kl.971



**90315**  
 kl.840-902

**90330**

**90315**  
 kl.840-902

**109639**

**155409**  
 kl.840-902

**155639**



**A3482** ago a destra stretto **A3481**  
**A3484** ago a sinistra stretto **A3483**

**A3487** ago a destra suola media  
**A3486**

**A3489** ago a sinistra suola media  
**A3488**



**A8021**

**A8022**

da 2 a 12 mm.

**A8023**

**A8024**

**PIEDINI NECCHI**



**A8025**

**A8026**

**A8027**

**A8028**

da 2 a 12 mm.



**A8029**

**A8030**

**A8031**

**A8032**

da 2 a 8 mm.



**A8033**

**A8034**

**A8035**

**A8036**

da 2 a 12 mm.

da 3 a 7 mm.



**A8037**

**A8038**

**A8040** gambo basso

**A8041** gambo alto

da 4 a 7 mm.

mm.4,8 - 6 - 6,4 - 8 - 10 - 12



**A8039** esterno per piedino fino a mm. 8  
**A8039B** esterno per piedino fino a mm.10

**A8039/1** a 1 ago  
mm. 1 - 2

**A8004** liscio      **A8003** dentato  
mm.4,8 - 6 - 6,4 - 8 - 10

## PIEDINI PFAFF



<b>P051742</b> kl.463 <b>P51742SD</b>	<b>A833/5</b> mm.5 <b>A833/3</b> mm.3	<b>P55030</b> Pfaff 438 zz mm 3,5	<b>P55112</b> zz mm 4,5	<b>P054501NO</b> zz mm 6	<b>P55106</b> zz mm 10
---	--	--------------------------------------	----------------------------	-----------------------------	---------------------------



<b>A664</b> Normale	<b>A665</b> largo	<b>A664TPA A665TPA</b> trasporto ago	<b>A662TPA</b>	<b>A717TPA</b>	<b>A718TPA</b>	<b>A832ATA</b> cerniere invisibili
KL.461-481 trasporto ago						



<b>A832TA</b> Cerniere invisibili	<b>A659TPA</b> cerniere stretto	<b>A896</b> suola mm.5,4 <b>A896L</b> suola mm.7 KL.461-481 trasporto ago	<b>A897</b> mm.5,4	<b>A897L</b> mm.7	<b>A898</b> mm.5,4	<b>A898L</b> mm.7
--------------------------------------	------------------------------------	---	--------------------	-------------------	--------------------	-------------------



<b>A896SXD</b> Cerniere regolabile Doppio	<b>A894</b> destro compensatori trasp.ago per kl.461-481 1/32 - 1/16 - 1/8 - 3/16 - 1/4 - 3/8 - 1/2 <b>A899</b> compensatore doppio 1/16	<b>A895</b> sinistro	<b>46682</b>	<b>26473</b>	<b>26474</b>	sinistro destro doppio <b>P620 P610 P630</b> 1/32 <b>P621 P611 P631</b> 1/16 <b>P613</b> 3/16 <b>P614</b> 1/4
KL.134-234 gambo lungo						

**PIEDINI SINGER**



**241375**  
mm.3

**210564**

**210569**  
mm.5

**521Z**  
kl.107-457

**411314-4**

**411314**



**503736**

**503660**

**23705**  
(266125)

**241414**  
kl.107-457

**107CR**

**107CL**



**PFA1R**

**PFA1L**

**457SH**  
mm.2,5-3-4-5-6

**S457AT**  
guidanastro regolabile  
kl.107-457

**23771S**  
guidanastro regolabile mm.6-8-10-12



**107SCL**  
compens.zz.sinistro  
guida elastica  
kl.107-457

**107SCR**  
compens.zz.destro  
guida elastica

**MS112**  
applicazione fettucce ripiegate  
3/16 - 1/4  
kl.112-212

**S570REG**  
2 aghi con guida reg.  
3/16 - 1/4  
kl.112-212

**259635**  
2 aghi stretto  
1/8 - 3/16 - 1/4  
kl.112-212

**PIEDINI SINGER**



<p><b>S570G</b> guidanastro reg.zz kl.107-457</p>	<p>pieдини per 2 aghi Singer-Brother-Juki <b>per la numerazione e misure vedi sezioni "Ricambi Singer" "Ricambi Brother" e "Ricambi Juki"</b></p>	<p><b>S570</b> piedino due aghi guida elastica destro <b>S570L</b> sinistro <b>S570DG</b> doppio distanza aghi:1/8-3/16-1/4-5/16-3/8-1/2 battuta guida: 1/32-1/16</p>	<p><b>S570C</b> 1/8-3/16-1/4-3/8</p>
---	---	---	--



<p><b>MT107</b> piedino teflon zz kl.107-457</p>	<p><b>MT112</b> piedino teflon 2 aghi da 1/8 a 1/2 kl.112-212</p>	<p><b>541566</b></p>	<p><b>541781</b> tipo per nervature piedini ZZ per Singer kl.20U</p>	<p><b>543939</b></p>
--	---	----------------------	--	----------------------



<p><b>139138</b> 3/16 - 1/4 kl.231-261</p>	<p><b>139223</b> 1/4 kl.231-261</p>	<p><b>139245</b> 3/16-1/4 kl.231-261</p>	<p><b>139405</b> 3 aghi in linea kl.231-261</p>	<p><b>148865</b> 3 aghi non in linea 1/4 kl.261 Singer e 926 Brother</p>
--	---	--	---	--

**TRASFORMAZIONE PER MACCHINA A BRACCIO ROVESCIATO**

per Singer - Necchi - Brother

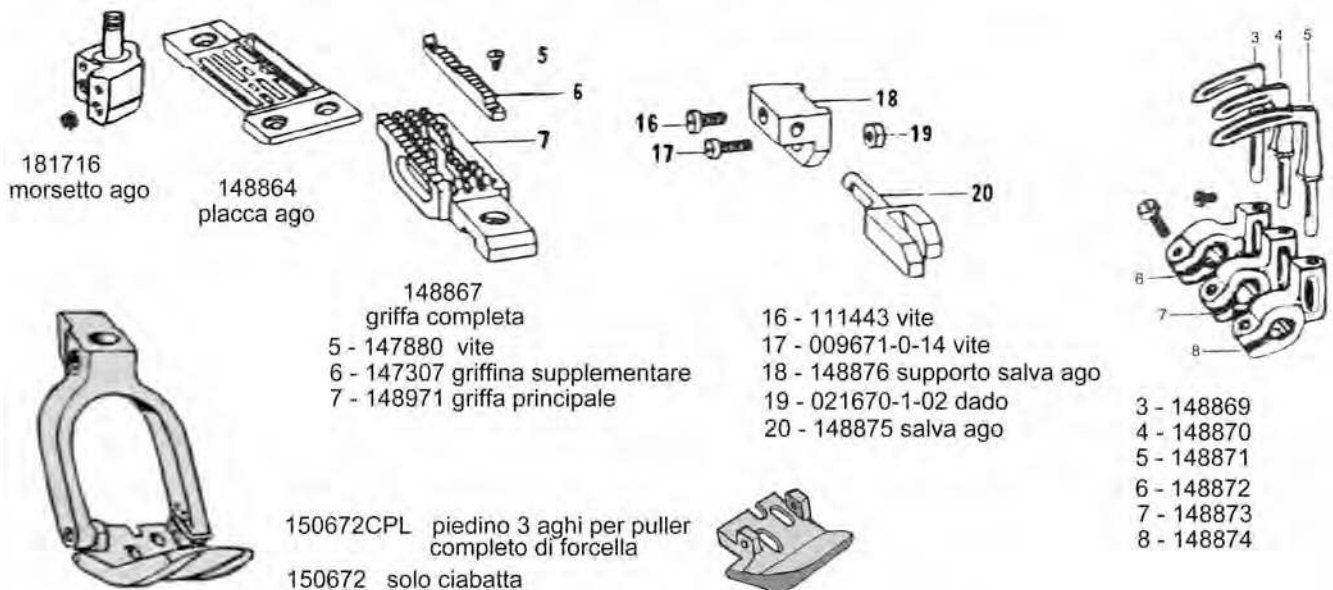

Per leggero: vedi ricambi Brother a pag 201